



**BARCO MAGIK II Interface**  
R9828122

### **Federal communication commission (FCC statement)**

This equipment has been tested and found to comply with the limits for a class B digital device, pursuant to Part 15 of the FCC Rules and EN55022. These limits are designed to provide reasonable protection against harmful interference when the equipment is operated in a commercial environment. This equipment generates, uses, and can radiate radio frequency energy and, if not installed and used in accordance with the instruction manual, may cause harmful interference to radio communications. Operation of this equipment in a residential area is likely to cause harmful interference in which case the user will be required to correct the interference at his own expense.

### **Instructions to the user :**

If this equipment does cause interference to radio or television reception, the user may try to correct the interference by one or more of the following measures :

- re-orientation of the receiving antenna for the radio or television.
- relocate the equipment with respect to the receiver.
- plug the equipment into a different outlet so that the equipment and receiver are on different branch circuits.
- fasten cables connectors to the equipment by mounting screws.

**Note : The use of shielded cables is required to comply within the limits of Part15 of FCC rules and EN55022.**

Due to constant research, the information in this manual is subject to change without notice.

Produced by BARCO NV, Feb. 2004.  
All rights reserved.

*\* IBM is a trademark of International Business Machine Incorporated*

Trademarks are the rights of their respective owners.

### **BARCO n.v./Projection Systems**

Noordlaan 5  
B-8520 Kurne  
Belgium  
Tel : +32/56/368211  
Fax : +32/56/351651  
E-mail : sales.bps@barco.com  
Visit Barco at the web : <http://www.barco.com>



## TABLE OF CONTENTS

|   |            |
|---|------------|
| <b>SAFETY INSTRUCTIONS</b> .....                        | <b>1-1</b> |
| On safety .....   | 1-2        |
| On installation .....                                   | 1-3        |
| On servicing .....                                      | 1-4        |
| On cleaning .....                                       | 1-4        |
| On repacking .....                                      | 1-4        |
| <br>  |            |
| <b>DESCRIPTIONS &amp; CONNECTIONS</b> .....             | <b>2-1</b> |
| Application Global .....                                | 2-1        |
| Specifications Magik II Interface .....                 | 2-1        |
| Front Side of the Interface .....                       | 2-2        |
| Back Side of the Interface .....                        | 2-3        |
| Computer Interface application drawing .....            | 2-4        |
| Power Connection .....                                  | 2-4        |
| Interconnection Interface / Computer .....              | 2-4        |
| Interconnection Interface output / display device ..... | 2-5        |
| <br>  |            |
| <b>MOUNTING WITH BRACKET</b> .....                      | <b>3-1</b> |
| <br>  |            |
| <b>OPTIONS</b> .....                                    | <b>4-1</b> |

# 1

## SAFETY INSTRUCTIONS

### Notice on Safety

This equipment is built in accordance with the requirements of the international safety standards EN60950, UL 1950 and CSA C22.2 No.950, which are the safety standards of information technology equipment including electrical business equipment.

These safety standards impose important requirements on the use of safety critical components, materials and isolation, in order to protect the user or operator against risk of electric shock and energy hazard, and having access to live parts.

Safety standards also impose limits to the internal and external temperature rises, radiation levels, mechanical stability and strength, enclosure construction and protection against the risk of fire.

Simulated single fault condition testing ensures the safety of the equipment to the user even when the equipment's normal operation fails.

### INSTALLATION INSTRUCTIONS

**Before operating this equipment please read this manual thoroughly, and retain it for future reference. Installation and preliminary adjustments should be performed by qualified BARCO personnel or by authorized BARCO service dealers.**

### OWNER'S RECORD

The part number and serial number are located at the bottom side of the interface. Record these numbers in the spaces provided below. Refer to them whenever you call upon your BARCO dealer regarding this product.

PART NUMBER :

SR. NUMBER :

DEALER :

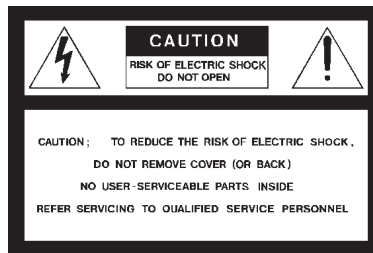

**WARNING  
TO PREVENT FIRE OR ELECTRICAL SHOCK HAZARD, DO NOT  
EXPOSE THIS EQUIPMENT TO RAIN OR MOISTURE**

### FEDERAL COMMUNICATION COMMISSION (FCC STATEMENT)

This equipment has been tested and found to comply with the limits of a class B digital device, pursuant to Part 15 of the FCC Rules and EN55022.

These limits are designed to provide reasonable protection against harmful interference when the equipment is operated in a residential environment. This equipment generates, uses and can radiate radio frequency energy and, if not installed and used in accordance with the instruction manual, may cause harmful interference to radio communications. However, there is no guarantee that interference will not occur in a particular installation. If this equipment does cause harmful interference to radio or television reception, which can be determined by turning the equipment off and on, the user is encouraged to try to correct the interference by one or more of the following measures :

- Reorient or relocate the receiving antenna.
- Increase the separation between the equipment and receiver.
- Connect the equipment into an outlet on a circuit different from that to which the receiver is connected.
- Consult the dealer or an experienced radio/TV technician for help.

**Note : The use of shielded cables is required to comply within the limits of Part 15 of FCC rules and EN55022.**

- ⊗ All the safety and operating instructions should be read before using this unit.
- ⊗ The safety and operating instructions manual should be retained for future reference.
- ⊗ All warnings on the equipment and in the documentation manuals should be adhered to.
- ⊗ All instructions for operating and use of this equipment must be followed precisely.

### On safety

1. This product should be operated from an AC power source.  
This interface may be connected to an IT-power system.

### POWER REQUIREMENTS

Power requirements for electrical equipment differ from area to area. This instrument adjusts itself for any input voltage between 85VAC and 245VAC automatically.

2. This product is equipped with a 3-wire grounding plug, a plug having a third (grounding) pin. This plug will only fit into a grounding-type power outlet. This is a safety feature. If you are unable to insert the plug into the outlet, contact your electrician to replace your obsolete outlet. Do not defeat the purpose of the grounding-type plug.

**WARNING FOR THE CUSTOMER:** THIS APPARATUS MUST BE GROUNDED (EARTHED) via the supplied 3 conductor AC power cable. (If the supplied power cable is not the correct one, consult your dealer.)

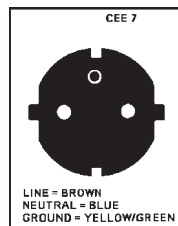

**If the Power cord of the Interface is equipped with a CEE 7 PLUG,**

#### A. Mains lead (Power cord) with CEE 7 plug :

The wires of the mains lead are colored in accordance with the following code.

- Green & Yellow : Earth (safety earth)
- Blue : Neutral
- Brown : Line (live)

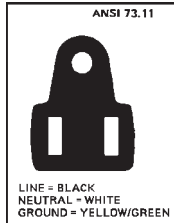

If the Power cord of the Interface is equipped with a ANSI 73.11 PLUG,

**B. Power cord with ANSI 73.11 plug :**

The wires of the power cord are colored in accordance with the following code.

- Green / Yellow : Ground
- White : Neutral
- Black : Line (live)

3. Do not allow anything to rest on the power cord. Do not locate this product where persons will walk on the cord.  
To disconnect the cord, pull it out by the plug. Never pull the cord itself.
4. If an extension cord is used with this product, make sure that the total of the ampere ratings on the products plugged into the extension cord does not exceed the extension cord ampere rating. Also make sure that the total of all products plugged into the wall outlet does not exceed 15 amperes.
5. Never push objects of any kind into this product through cabinet slots as they may touch dangerous voltage points or short out parts that could result in a risk of fire or electrical shock.  
Never spill liquid of any kind on the product. Should any liquid or solid object fall into the cabinet, unplug the set and have it checked by qualified service personnel before resuming operations.
6. Lightning - For added protection for this video product during a lightning storm, or when it is left unattended and unused for long periods of time, unplug it from the wall outlet. This will prevent damage to the projector due to lightning and AC power-line surges.

**On installation**

1. Do not use this equipment near water.
2. To ensure reliable operation of the product and to protect it from overheating, these openings must not be blocked or covered. The openings should never be blocked by placing the product on a bed, sofa, rug, or other similar surface. This product should never be placed near or over a radiator or heat register.

### **On servicing**

Do not attempt to service this product yourself, as opening or removing covers may expose you to dangerous voltage potential and risk of electric shock!

**Refer all servicing to qualified service personnel.**

**Unplug this product from the wall outlet and refer servicing to qualified service personnel under the following conditions :**

- a. If liquid has been spilled into the equipment.
- b. If the product has been exposed to rain or water.
- c. If the product does not operate normally when the operating instructions are followed.
- d. If the product has been dropped or the cabinet has been damaged.
- e. If the product exhibits a distinct change in performance, indicating a need for service.

**Note : Adjust only those controls that are covered by the operating instructions since improper adjustment of the other controls may result in damage and will often require extensive work by a qualified technician to restore the product to normal operation.**

**Replacement parts** - When replacement parts are required, be sure the service technician has used original BARCO replacement parts or authorized replacement parts which have the same characteristics as the BARCO original part. Unauthorized substitutions may result in degraded performance and reliability, fire, electric shock or other hazards. Unauthorized substitutions may void warranty.

**Safety check** - Upon completion of any service or repairs to this **MAGIK II INTERFACE**, ask the service technician to perform safety checks to determine that the product is in proper operating condition.

### **On cleaning**

**Unplug this product from the wall outlet before cleaning. Do not use liquid cleaners or aerosol cleaners. Use a damp cloth for cleaning.**

- To keep the cabinet looking brand-new, periodically clean it with a soft cloth. Stubborn stains may be removed with a cloth lightly dampened with mild detergent solution. Never use strong solvents, such as thinner or benzene, or abrasive cleaners, since these will damage the cabinet.

### **On repacking**

Save the original shipping carton and packing material; they will come in handy if you ever have to ship your equipment. For maximum protection, repack your set as it was originally packed at the factory.

# 2

## DESCRIPTIONS & CONNECTIONS

### APPLICATION GLOBAL

Purpose of this interface is to take RGB signals from a source and to display them on a large screen projector, while through RGB HV O/P.

Active loop-trough is used for a monitor output.

RGB signals from the computer are automatically terminated to 75 Ohm, while sync signals, which are TTL signals are terminated with a 22K pull-up resistor.

### SPECIFICATIONS MAGIK II INTERFACE:

Measured bandwidth : >300MHz @ -3dB.

Rise and fall time better than 1.42 ns

Gain fixed to 1. (Output = Input)

Input : R,G,B, :0.7 Vpp (no sync) or 1Vpp With sync @ 75 Ohm

Sync : TTL / Analog selected through a switch

Output signals :

Loop trough output on DD15 connector:

R, G, B: 0.7 Vpp (no sync) or 1Vpp @ 75 Ohm

Horizontal Sync: TTL

Vertical Sync: TTL

Composite Sync: TTL

Output to projector on 5 BNC connectors:

R,G,B: 0.7 Vpp (no sync) or 1Vpp @ 75 Ohm

Horizontal Sync: 1.54Vtt

Vertical Sync: 1.54Vtt

Composite Sync: 1.54Vtt

Power supply: Auto ranging Power Supply 87-240V AC 50/60Hz



**FRONT SIDE OF THE INTERFACE:**

**- Power indicator.**

When the mains is connected this LED will indicate the power supply of the unit is up and running.

- |   |            |     |   |
|---|------------|-----|---|
| 1 | LED        | --- | Power   |
| 2 | LED        | --- | Indicates if Horizontal / Composite Sync is present |
| 3 | LED        | --- | Indicates if Vertical Sync is present               |
| 4 | Connectors | --- | RGB H V Input                                       |
| 5 | Switch     | --- | To select Analog / Digital incoming Sync            |

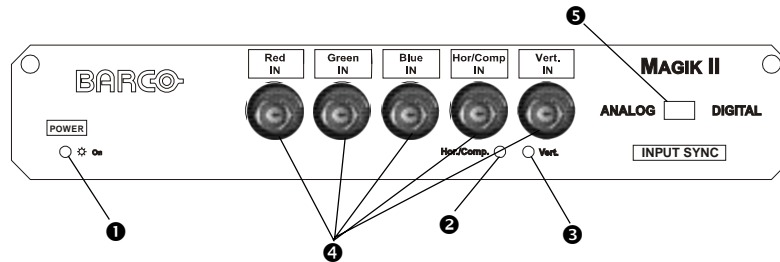

**BACK SIDE OF THE INTERFACE:**

-**DD15 output** connector, labeled "**MONITOR OUT**"

The Monitor that was originally connected to your computer can be connected here for local monitoring the images you want to be projected on your screen.

With an optional cable your Apple Mac Monitor can be connected to the interface.

-**5 BNC connectors.** These are the connection to the projector. R,G,B signals have standard levels and should be terminated 75Ω.

The Hor/Comp OUT BNC is outputting composite sync when no 75Ω is connected to the Vert. OUT BNC. If there is a 75Ω load on the Vert. OUT; then a Horizontal sync signal is available on this output.

The Vert. output is providing Vertical sync signals and should be terminated 75 Ohm if used.

-**Two green LEDs** indicating signal presence at the sync outputs are available.

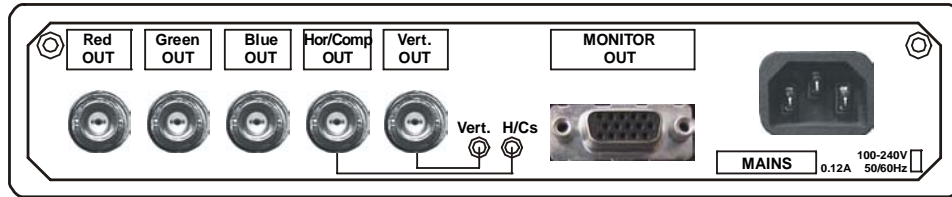

COMPUTER INTERFACE APPLICATION DRAWING

Power connection



Interconnection Interface / Computer

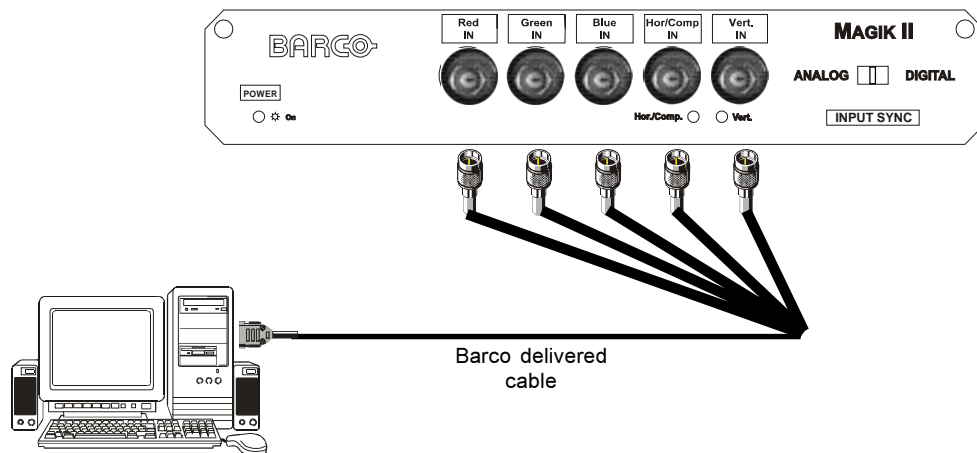

**Interconnection Interface output/display device**

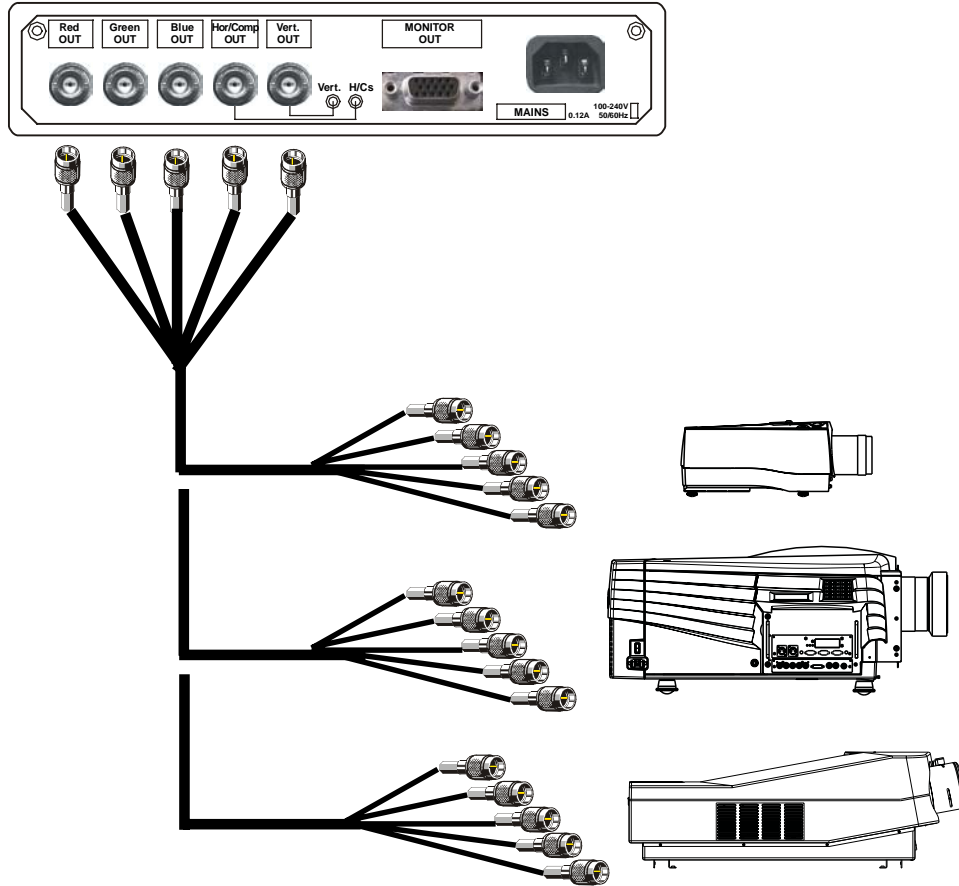

# 3

## MOUNTING WITH BRACKET

FOR EASY MOUNTING OF MAGIK II INTERFACE AT THE BOTTOM OF A TABLETOP, A BRACKET AND A SET OF WING SCREWS ARE INCLUDED IN THE PACKING.

### Step 1

Unpack the bracket from the packing.

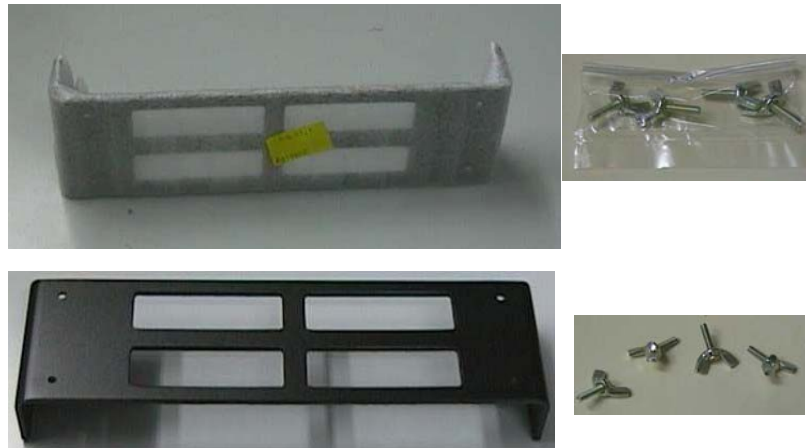

(Step 1)

### Step 2

Fix the wing screws into the 4 side holes of the bracket, but they should not go beyond the bracket surface.

(Step 2)



*Mounting with Bracket*

---

**Step 3**

Mount the bracket on the tabletop with screws (countersunk head Dia 3) as shown in the figure. The minimum length for mounting screws should be greater than 10 mm. Ensure proper fixing of these screws, so that the heads will not touch the Interface.



(Step 3)

**Step 4**

Take the Magik II Interface and slide it in the bracket. Tighten the wing screws one diagonally on each side into the slot provided in the side of the Magik II Interface (as shown in figure) and then tighten all four screws.

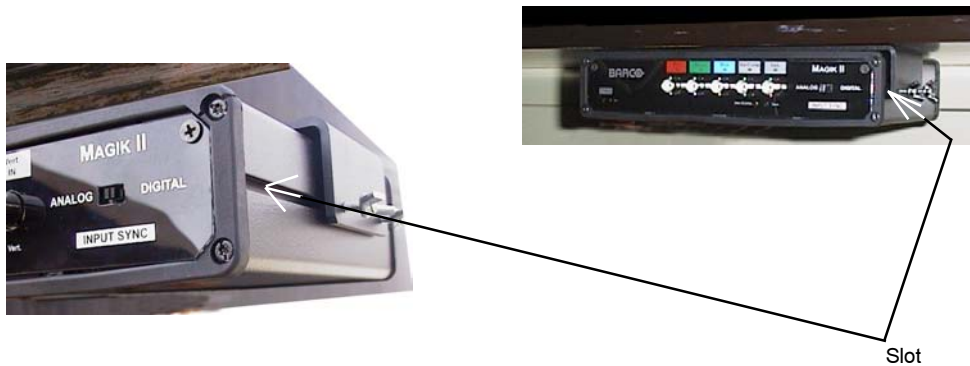

(Step 4)

# 4

## OPTIONS

### 19" RACK MOUNTING KIT FOR THE MAGIK II:

This kit (order no. R9828970) is used to mount Magik II Interface to a standard 19" rack. Two interfaces can be mount per kit.

